

ACCURL PRODUCT RANGE:

GENIUS PLUS / EUROMASTER / EB ULTRA
Large Size / Medium sizes / SMALL sizes



ES NT-30T



MASTERLINE
ALL sizes



SMART BEC
Medium sizes

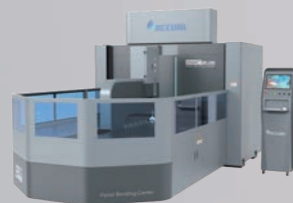

ACCURL MACHINE TOOLS
ANHUI | CHINA

Industrial Park in Bowang Special
Economic Zone Maanshan
Anhui | China

T | +86 0555 2780563
M | +86-188 5555 1088
E | info@accurl.com

ACCURL.com

LOCAL DEALER:

Shaping your future

HYBRID
▶▶ GENIUS



SUSTAINABLE BENDING SOLUTIONS

Bending ... has never been easier.

GENIUS PLUS

Technology and Precision
more accessible

Using all the technology EURO PRO model combines quality,
performance and accuracy at a competitive price.



↳ Your production is unique,
and your tools must be **made to measure.**



INDUSTRY 4.0 READY

- < Connection to company LAN and ERP
- < Interface to other machine tools
- < Remote assistance and diagnostics



GREEN HYBRID SERVO

- < Up to 35% Energy Saving
- < Maximum CO² and oil reduction
- < Maximum return on your investment



HIGH PERFORMANCES

- < More than 35% higher productivity
- < Ram Speed 200 mm/s
- < Z-axis Speed 800 mm/s



HIGH DYNAMIC Y-AXIS CONTROL

- < Over 30% higher productivity

**DON'T SETTLE
FOR A STANDARD PRESS BRAKE,
CHOOSE A SUPERCUSTOM!**

STANDARD

- > 550~650mm daylight and 90°mm tool adapters
- > 300mm stroke
- > ACCURL® EVO-GO Hybrid servo System
- > DELEM DA66T 2D graphical Control Unit
- > ACCURLBGA-4 with X,R,Z1,Z2-axis
- > Any tonnage and size
- > Lasersafe CE Norms: Lasersafe IRIS Systems
- > Ready for Industry 4.0
- > Assistance and connectivity
- > Custom day ghts and strokes
- > with tailored analysis
- > ACCURL® "WILA WAVE" Wedge Ultra CNC Corning



AVAILABLE
FEATURES
AND OPTIONALS



GREEN HYBRID SERVO TECHNOLOGY:

The standard range features models with capacities varying from 40 to 3000 ton. Furthermore, ACCURL is capable of building machinery with different configurations upon customers' request.

Speed More than 200mm/s

BENEFITS COMPARED TO A TRADITIONAL PRESS

Energy consumption:	-35%
Automatic standby:	Start and stop
During programming and bending:	Zero consumption
Oil duration:	2 times higher
Productivity for reduced cycle times:	+30%

Expanded CNC to view consumption in real time and estimate production costs

AFFORDABLE TECHNOLOGY

ACCURL one step beyond Using all ACCURL's knowledge and technology, GENIUS models combine quality, performance and accuracy for those company's that wants to embrace future sustainable development.



HYBRID GENIUS NEXT

- Up to 35% Energy Saving
- More than 35% higher productivity
- Precise bending result at fast speed
- Minimalized tool change and adjustment time
- Maximized speed and safety

Manufacturing Efficiency, Energy efficiency, Ergonomics:

ACCURL offers Genius Press Brakes with different configuration but with a common characteristic, high quality. The decision to purchase must focus on choosing the most appropriate equipment for the job to be done, taking into account the gain of each of them.

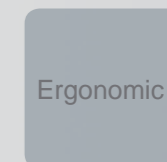
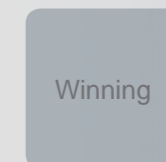
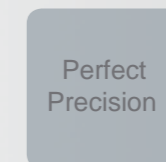
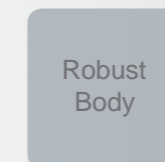
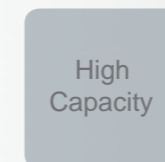

ADVANCED TANDEM ADAPTOR SOLUTION

Advanced Tandem Adaptor solution synchronises safety functions and control across both machines and when paired with the dedicated LZS-XL optical system, it provides flexible guarding in both single and tandem configurations.

35%
ENERGY
CONSUMPTION



RapidBend can improve machine performance and efficiency by up to 72% to significantly enhance your productivity.

Bending length 2.0-8m

Bending force 60-3000tn

HIGH RELIABILITY AND MAXIMUM PRODUCTIVITY

The Genius features the advantages of high acceleration, deceleration and fast response times of the hybrid servo drive system. Compared to conventional press brakes considerable productivity increase can be reached; reduction of cycle times by up to 30 % and more is the reality.

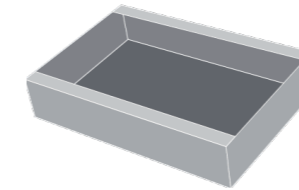

Time cycle comparison

Bending time necessary to realize this 6 bend box-only machine time



Genius Hydraulic
180mm/s



Genius Hybrid
220mm/s



eB Ultra
Electric Servo
220mm/s



RESPECT FOR THE ENVIRONMENT
ENERGY SAVING*
REDUCED NOISE*
LESS WASTE*
EXTREME PRECISION
REPEATABILITY

Machine LED status®



— Motor OFF — Reset OK



— Motor ON — Reset OK



— Motor ON — Reset OK — DNC OK

ACCURL GREEN INTEGRATED NATURE

Thanks to the high dynamic electro mechanic drive system and "IRIS" safety 35% shorter cycle times on an average.

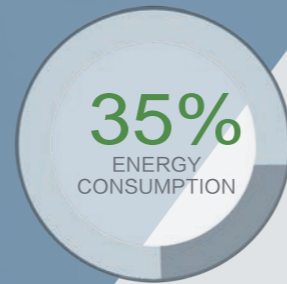

ADVANTAGE:

- **Part quality**
 - High repeating accuracy due to
 - The servo-motor, with closed loop speed control
- **Low Noise**
 - GENIUS PLUS allows up to 60% less noise than other machines



ACCURL® HYBRID SERVO EVO-GO

ACCURL® promotes a friendly environmental policy and as such, all our equipment features the EVO-GO hybrid technology, and the EVO-GO approach has a dual value: eco-nomy to optimize company resources utilization; eco-logy to take care of the environment for a better future.

/ COMPARISON

- The Genius Hybrid press brake provides greater profit the higher is the machine occupancy rate.

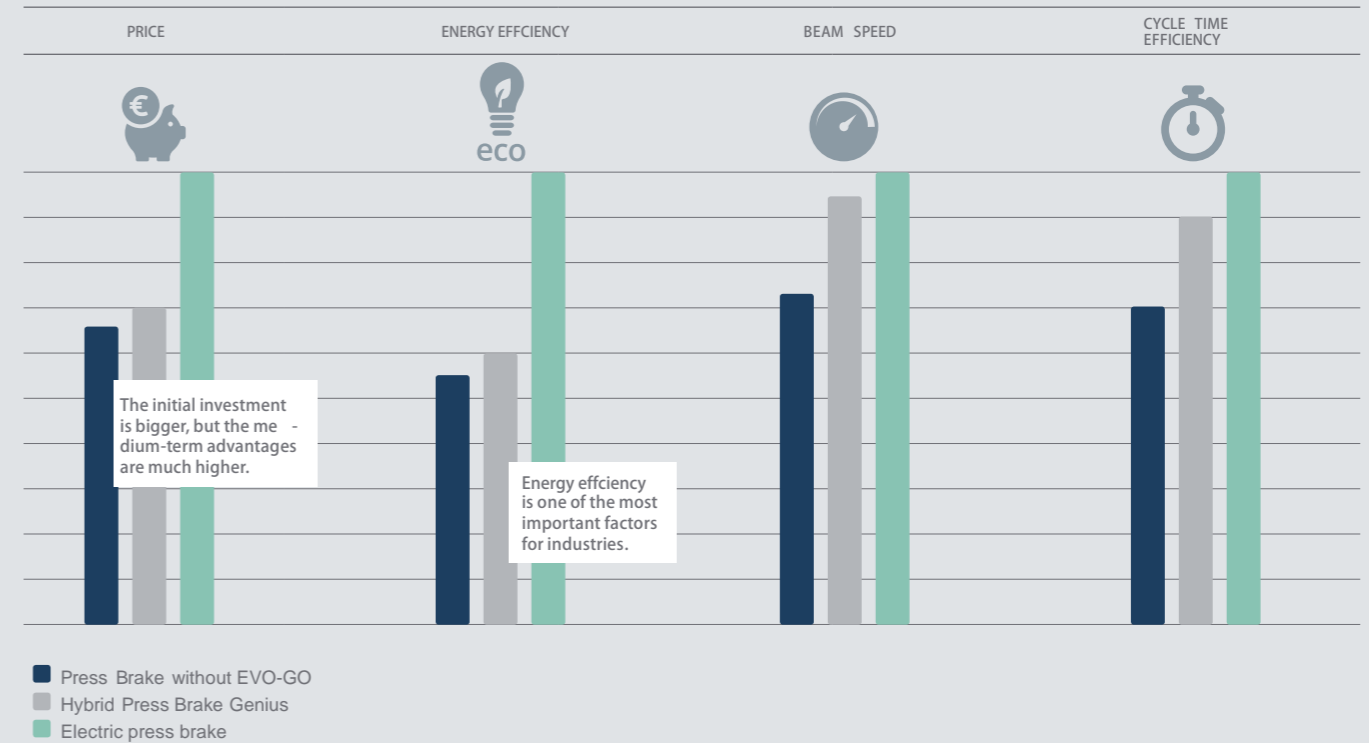

THE "GREENER" COMPETITIVENESS:

- **Energy saving**
 - 35% lower consumption than hydraulic brakes on an average.
- **Productivity**
 - Thanks to the high dynamic electro mechanic drive system and "IRIS" safety 35% shorter cycle times on an average.

Everything with one click in 3 steps. 100% automated

Optional item FABLE is an acronym of Fully Automated Cut & Bend BundLE and the operator has to set only the initial parameters: FABLE software and algorithms will handle the entire process in a fully automated way, including unfolding.

FULLY IN 3D, CUT BEND THE SHEET METAL



Job tracking add-on

Record and monitor the production\manufacturing process\flow
 Store all parts, tubes, daily jobs, SubNests.Sort and filter all the data, and search using complex search queries.
 Manage and monitor material consumption and usage efficiency

©Optional*

FABLE IN ACTION: 1,2 e 3. UNFOLDED,CUT AND BEND

ACCURL. Claim For 3D Unfolding

Consisting of a suite of outstanding applications,ACCURL.CLAIM allows you to fully control alle the phases of the creative process, converting ideas into technical drawings ready to be sent to the sheet metal working software.

ACCURL. iCut Nesting For Cutting

With ACCURLiCut software is designed to allow you to achieve the best cutting results, saving material, reducing time & making things easier for the operator, thanks to the high level of automation.

ACCURL. iBend Offline For Bending

Powerful and reliable, create or import geometric details in a moment from any other design platform, automatically optimizing their profiles and optimally preparing them for subsequent processing.

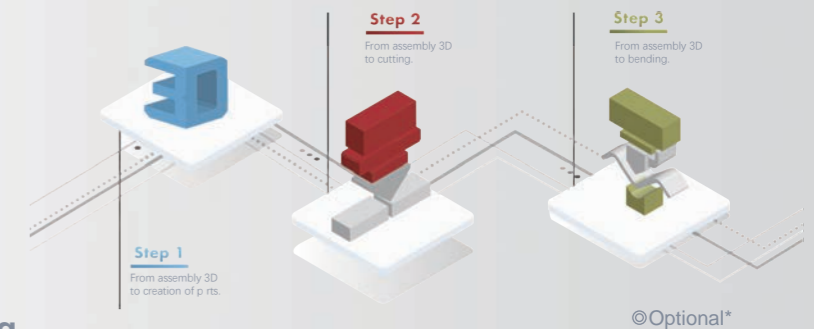

JopTRACK For Shop Management

For every 4 main phases of metal sheet cutting (quotation and order confirmation, order elaboration and warehouse checking for production) the JobTRACK system by ACCURL offers the more suitable software able to support at best the workforce in the relevant decisions and schedules.



From offer request to the order confirmation. Rapid and efficient.



The Production Manager open the internal order issued by sales dept. and he creates a list of works to elaborate in the production dept.



Order Working
 The machine is ready. The operator checks nesting and start the machine.



Warehouse Check for the production
 From the Production Manager to the warehouse's workers. It's sent the request to prepare the necessary materials for the production with real-time updates of stocks.

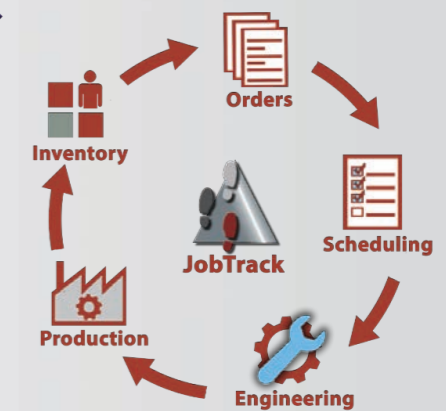

iBend OFFLINE 3D-SOFTWARE*

Production preparation in line with press brake user friendliness:
ACCURL® iBend 3D is an application for programming and simulating CNC press brakes to aximize production resources.

ACCURL.iBend

Offline 3D press brake simulation by Accurl

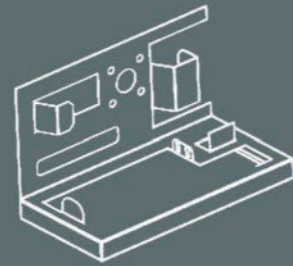

iBEND OFFLINE 3D SEQUENCING AND SIMULATION SOFTWARE

ACCURL. iBend enables offline generation of bend sequences and tooling setups, with dynamic 3D simulation for checking collisions of the part with tools, fingers, and machine components.

ADVANTAGES: ACCURL iBEND ENHANCES YOUR PRODUCTIVITY:

- Direct part transfer from SolidWorks, Solid Edge, and Inventor
- Importing and unfolding of IGES and STEP 3D parts
- Importing and folding flat DXFDWG parts with layer filtering
- 3D simulation of the bending process with collision detection
- Faster design-to-production times with automated features
- Offline programming means minimal machine down-time

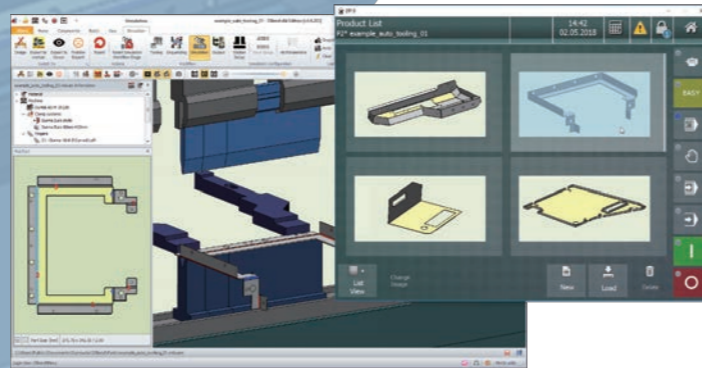

BEND SEQUENCE SELECTION:

ACCURL .iBend automatically calculates multiple bend sequences, taking into consideration:

- Collision avoidance
- Tool segment availability
- Heel tools for over-hanging flanges

©Optional*

SETUP REPORTS

The iBend comes with real-time, **automatic 3D simulation**, presenting a realistic visualization of the bending process. and the simulation helps you to create an error-free process, producing NC code or a bending report.

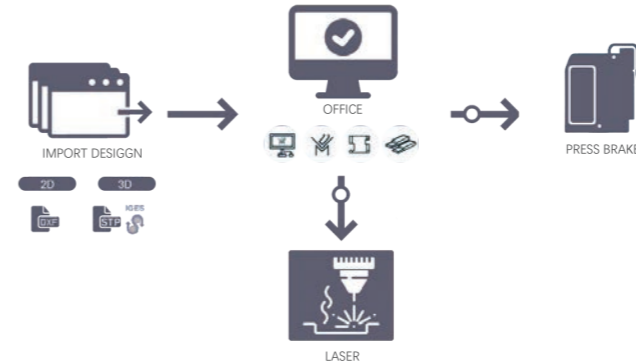

ADVANTAGE

- Bend sequence instructions
- Tool information and tool setup details
- Product handling
- Bend-by-bend graphics
- Bend sequence instructions
- Flat view with the bend sequence
- You can generate your report files in several formats: PDF, DOC, RTF, XLS\XLSX, XML, CSV, and RPT

3D SIMULATION AND COLLISION DETECTION

Automatic simulation and collision detection for part, fingers tools, and machine:

ADVANTAGE

- Detect collisions between all moving elements
- Visualize bending (overbend, springback) realistically
- Simulate operator part handling
- Simulate the bending sequence with the full machine configuration in 3D-fingers tools, part, and machine

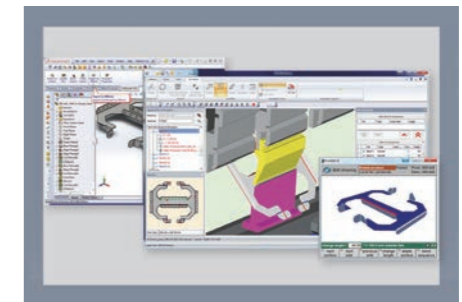

EFFICIENT TOOL SELECTION

ADVANTAGE

- availability of tool geometry and segments
- Bend radius
- Maximum force
- Collision avoidance
- **Full support for hemming:**
 - Specify default hemming tools for automatic selection
 - Default and editable Pre-bend angle.



Press brake bending.

ADVANCED SAFETY

CE Safety Regulations require the application of an Optical Safety Guard (OSG) when operating at closing speed



ANGLE MEASUREMENT

Automatic angle measurement and automatic correction of the bending angle

©Optional*

OPTICAL PROTECTION TECHNOLOGY

The IRIS System safety equipment by LaserSafe represents the most advanced safety solution for press brakes. In terms of productivity and protection level. Its unique features increase the competitiveness of the eP-Press:

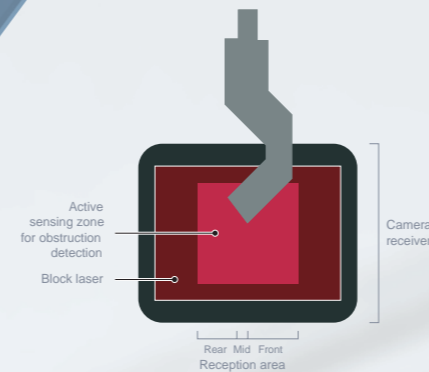

Applies to IRIS and IRIS Plus

IRIS TO MAXIMIZE SAFETY, PRODUCTIVITY AND TOOL CRASH PROTECTION:

- Faster cycle times
- Speed change at 2 mm above material
- Ultimate Operator Safety
- Security against tooling damage
- Full Integration in the CNC System
- Automatic Alignment
- Angle measurement option

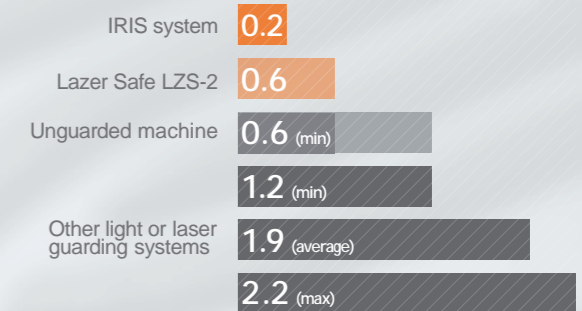

Comparison time in slow speed closing (seconds per cycle)

ANGLE CONTROL PROCESSES

These are two examples of angle control processes that can be implemented in the CNC system through the development of supporting software.



DYNAMIC ANGLE CONTROL • Dynamic Angle Control uses real time angle data plus the recorded spring back value to automatically and accurately control the bending depth. The dynamic angle control is a high speed process that ensures accuracy and consistency between parts with no delay to the bending operation.

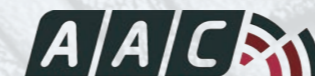

ACTIVE ANGLE CONTROL • Active Angle control is a highly accurate angle control process that calculates spring back for each individual bend, then controls the bend depth with Live Angle Bending to achieve the correct angle.

	IRIS INTEGRATED REAL-TIME IMAGING SYSTEM	IRIS PLUS INTEGRATED REAL-TIME IMAGING SYSTEM
Optical protection functions	•	•
Optical imaging functions	•	•
Maximum recommended optical range	8 metres	4.5 metres
Optical sensor		
Camera	Digital Image Sensor	Digital Image Sensor
Frame rate / frequency	10ms/100Hz	10ms/100Hz
Data resolution (sensor)	-	0.01 degrees
Measurement technology		
Type	Integrated High-Speed Image Processor	Integrated High-Speed Image Processor
Memory depth	-	Records up to 10 seconds (1000 images) of bend data per cycle.
Measurement accuracy	-	Up to +/- 0.25 degrees
Measurement rate	-	10ms/100Hz (synchronised with frame rate)
Imaging technology		
Bend Speed Management*	•	•
BendVision*	-	•

*Supporting software development is required for the CNC system.

STATE OF THE ART FLEXIBLE SOLUTIONS

The DA-60S flagship control combines solid fundamental press brake control functionality with the latest of enhancements increasing productivity. Next to highest accuracies, ease-of-use for the operator it makes today's press brakes more versatile than ever.



Everything under control

DA-60S
Touch

**STATE-OF-ART FUNCTION
COMPLETE**

The DA-69S offers 2D as well as 3D programming that includes automatic bend sequence calculation and collision detection. Full 3D machine set-up with multiple tool stations giving true feedback on the product feasibility and handling.

DA-60S - SERIES 3D GRAPHICAL CONTROL

The control operation, based on state-of-the art industrial touch screen technology, gives access to the proven renewed Delem user-interface and enables direct navigation between programming and production. Functions are directly located where you need them, offering optimised ergonomics throughout the application.

HARDWARE SPECIFICATIONS

- New ergonomic, premium, rugged design
- Linux based OS, improving performance
- 24" HD widescreen + industrial PCT touch screen technology
- New high performance platform, using latest industrial standards
- Large OEM-panel for switches, signals, etc.
- Easy access to all connections



DA-69S FEATURES:

- 3D and 2D graphical touch screen programming mode
- 3D visualisation in simulation and production mode
- 24" high resolution colour TFT
- Delem Modusys compatibility (module scalability and adaptivity)
- USB, peripheral interfacing
- Support for Industry 4.0 connectivity (OPC-UA option)
- Shop floor control, Job list functionality
- Open system architecture
- Sensor bending & correction interface
- Profile-S 3D offline software



©Optional*

Optional expansion

- Part support control
- Protractor interface
- TandemLink
- Barcode/2D reader interface
- Sheet thickness measurement
- Sensor bending / angle measurement control
- Optional 2 screen solution
- ACP, Additional Control Panel

WILA NEW STANDARD TOOL HOLDERS SYSTEM

The New Standard Tool Holders (Clamping, Crowning and Bottom Tool Holders) make it possible to change tools very quickly. When combined with our state of the art New Standard Tooling they also provide maximum accuracy flexibility, durability and safety



UPB / ES
Premium / Pro
HC / MC
HD
SL
STL

EFFICIENTLY CHANGE YOUR PRESS BRAKE TOOLS

ADVANTAGE:

- Innovative and extremely fast clamping systems
- Tailored to each individual press brake
- Top-quality materials that ensure a long life
- Horizontal and vertical change of tooling
- Available with hydraulic, pneumatic or manual clamping

WITH
PATENTED
SELF-LOCKING
PERFORMANCE®



©Optional*

POWERFUL SELF-LOCKING® PERFORMANCE

Tools can be locked and released extremely quickly using air pressure, while clamping force is provided by our patented Self-Locking mechanism. This unique combination results in a much faster tool change and increases your productivity in the long run.



PNEUMATIC CLAMPING WITH WILA NEW AIRPOWER SERIES

- Now available:

The complete range of WILA's pneumatic tool holders, top and bottom, Pro and Premium. Speed up operations and tool changes— and maximize productivity.

LEAN, CLEAN AND GREEN

- No oil, no hydraulics
- No pressure booster needed (6-8 bar will do)
- Ultrafast clamping for more productivity
- Lower operating costs
- For top and bottom tooling
- Cleaner, more sustainable
- For new and existing press brakes



New Standard Clamping

- Innovative and extremely fast clamping systems
- Equipped with Guards
- Horizontal and vertical change of tooling
- Can be installed on any press brake thanks to the UPB concept
- Suitable for New Standard top tools
- Available with hydraulic, pneumatic or manual clamping

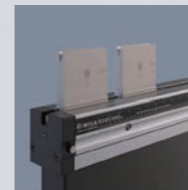

New Standard Crowning

- Tailored to each individual press brake
- Top-quality materials that ensure a long life
- Perfect compensation for deflection, resulting in a consistent bend angle over the entire length of the machine
- Using a range of patented adjustable wedges known as WILA Wave Wedges
- Can be operated CNC-controlled or by hand



New Standard Bottom Tool Holders

- Ideal for press brakes that do not require a crowning system, or for press brakes with a crowning system already incorporated into the lower beam
- Compact design with fully integrated clamping system for dies
- Available with hydraulic, pneumatic or manual clamping

INTERNATIONAL BENCHMARK FOR PRESS BRAKE TOOLING

ACCURL® press brake tools are made from WILA in Netherlands, are well polished and hardened.& ACCURL has wide range of bending tool solutions, such as 1V and multi-V lower tools and different upper tool solutions.

NEW STANDARD WILA TOOLING

WHY CHOOSE WILA NEW STANDARD TOOLING

- Fast and safe tool changes
- Self-seating and aligning
- High quality finish, maximum precision
- Long tool life, designed for flexibility
- Hardened contact surfaces 60HRc

©Optional*

PRESS BRAKE PRODUCTIVITY TOOLING FROM WILA:

The WILA tools with Safety-Click® & the E2M® changing system for (heavy) tools, have made the changeover process easier and safer.accuracy and ergonomics are optimally matched to achieve the highest productivity with all tools.

New Standard Premium Tooling:

- All compression and wear areas are fully CNC-Dee hardened® to 56-60 HRc for maximum durability
- Extreme precision and bending performance
- High workload and maximum durability
- Uncompromising long-term performance and quality
- Comply with complex requirements and extreme tolerances



Press Brake Tooling



Press Brake Tool Holders



Safety-Clicks



TOOL MANAGEMENT

If you are familiar with lean manufacturing principles, you understand the advantages of efficient tool management. Tools should be stored near the press brake for easy access. You should also be able to identify and enter them into the press brake control quickly and easily. This will save time and help prevent mistakes during changeovers. With proper care, maintenance, and tool storage, WILA Tooling will retain its accuracy for ten years or more.



SMART TOOLING APP

The WILA Smart Tooling App provides instant access to tool data anytime, anywhere. It offers major time savings, error-free tool data entry, and simplified tool inventory management. All WILA New Standard Premium tools feature a unique, scannable code, offering an Industry 4.0 Tool Management solution for digital tool data exchange.

BGA SERIES BACKGAUGE

FAST & ACCURATE WITH CONSTRUCTION

The ACCURL BGA series CNC backgauge to help with all your bending needs – let us help you configure the best solution for your press brake needs.



PERFECT POSITIONING

ACCURL options for back gauge systems and material handling complete the Press Brake

ENTIRELY ACCORDING TO CUSTOMER SPECIFICATION

No matter if 4, 5 or 6 axes, support bracket, sheet support or bending aid – you decide how your press brake will look like. We guarantee that your multi axis press brake can be configured to meet your needs and bending requirements exactly.

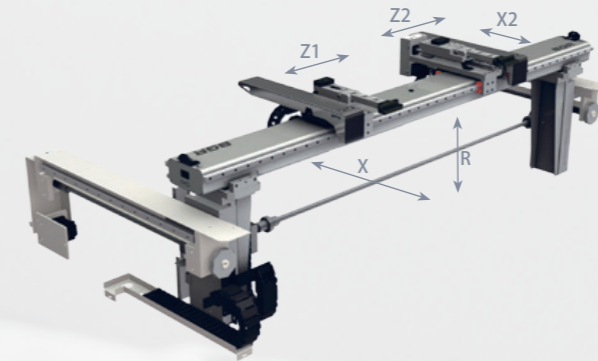

THE ACCURL OPTIONS-YOUR ADVANTAGES:

- Highest precision and dynamics with all back gauge systems – up to 1200 mm/s
- Back gauge systems can be selected according the requirements: 2, 4, 5 or 6 axes
- Time and effort-saving handling thanks to optimum bending aids
- Additional support brackets for light and thin sheet metals

SUPPORTS:

Sheet supports are auxiliary bending accessories. They must be chosen according to the dimensions and weight of the pieces.

Front supports: Support the plate during the front feed

Back supports: Support the plate in the approach to the back gauge

Follower supports: Support the movement of the plate during the bending



ACCURL believe in innovation and continuous improvement. For these reasons, ACCURL has created new servo sheet followers to support the sheet during the bend, avoiding excessive deformation.

- Light solution, easy to move
- AP1 - AP2 CNC-controlled interpolated axes
- Recommended for heavy parts or large thin plate
- bend as closed as 70°
- Load capacity – 160kg or 350kg per support.
- Brush and support shaft dim 350x900 up to 1200 mm

©Optional*



The SPA Thin supports system are installed in the fingers of the back gauge. They can be activated in predefined bending and enable the plate to slide until it lies adjacent to the back gauge.

ADVANTAGE:

- Back supports have ball sliders and brushes to protect even the most delicate surfaces
- Load capacity – 30 kg per support
- Best configuration for sheet box bending

©Optional*

CHOOSE AND CONFIGURE YOUR PRESS BRAKE

A territory with a consolidated technological background and the inventiveness of the ACCURL family are the ingredients of the birth of ACCURL. One of the first company to apply Industry 4.0 enters the world of sheet metal bending machines in China by ACCURL.

ACCURL MORE INNOVATION

SPECIFICATIONS

	Bending length	Tonnage	Throat depth	Beam stroke	Daylight	Daylight 2*	Fast	Bending	Return (RS)	RS Hybrid*	Oil capacity	Back gauge stroke	Motor Power	Total length (A)	Total height (B)	Total width (C)	Distance between frames	Height under the floor	Aprox. weight
	mm	Ton	mm	mm	mm	mm		Y axis speed											

Hybrid GENIUS

Ginius B2060	2050													3080			1600		6030
Ginius B2560	2550	60	400	300	550	650	210	0-10/18*	145	220	120	600	7,5	3580	2790	2030	2100	0	6620
Ginius B2580	2550	80												3580			2700		7640
Ginius B25110	2550													3600			2100		8060
Ginius B30110	3150													4100	2890	2090	2700	0	9230
Ginius B40110	4000	110	450	300	550	650	200	0-10/18*	145	220	180	650	7,5	4600			3300	0	10670
Ginius B42110	4200													5100			3700		12050
Ginius B30135	3150													4120			2700		10910
Ginius B40135	4050	135	450	300	550	650	200	0-10/17*	135	200	230	650	11	4620	2905	2160	3300	0	12590
Ginius B42135	4250													5120			3700		14080
Ginius B30175	3150													4120			2700		12220
Ginius B40175	4000	175	450	300	550	650	200	0-10/17*	155	205	230	800	15	4620	2965	2220	3300	0	14250
Ginius B42175	4200													5120			3700		15980
Ginius B30220	3150													4100			2700		15140
Ginius B40220	4000	220	450	300	550	650	200	0-10/17*	130	200	290	800	18,5	4600	3015	2220	3300	0	16410
Ginius B42220	4200													5100			3700		20200

Genius PLUS

Ginius B30250	3150													3940			2700		18080
Ginius B40250	4000	250	400	350	570	650	180	0-10/17*	130	205	390	750	19	4440	3440	2020	3300	0	19720
Ginius B42250	4200													4940			3300		20310
Ginius B30300	3150													3960			2700		19130
Ginius B40300	4000	300	400	350	570	650	180	0-10/17*	130	205	470	750	30	4460	3440	2020	3300	0	20730
Ginius B42300	4200													4960			3300		21410
Ginius B40400	4000	400	400	400	620	650	170	0-10	120	-	380	1000	30	4480	3755	2395	3300	0	25980
Ginius B42400	4200													4980			3300		26900
Ginius B40500	4000	450	400	400	620	650	140	0-10	105	-	380	1000	30	5100	3735	2395	3300	0	27000
Ginius B42550	4200													5500			3300		27670
Ginius B50500	5000	500	500	400	620	650	140	0-10	105	-	380	1000	37	6100	4300	2500	3950	0	38600
Ginius B60500	6000													7200			5100		43700