

ACCURL PRODUCT RANGE:

EUROMASTER
Medium sizes



EB ULTRA
SMALL sizes

ES NT-30T



MASTERLINE
ALL sizes



TUBELINE
ALL sizes



SMART BEC
Medium sizes

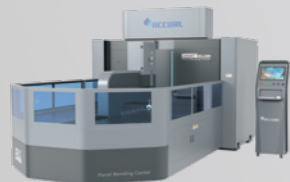

MasterLINE
NEXT

ACCURL MACHINE TOOLS
ANHUI | CHINA

Industrial Park in Bowang Special
Economic Zone Maanshan
Anhui | China

T | +86 0555 2780563
M | +86-188 5555 1088
E | info@accurl.com

ACCURL.com

LOCAL DEALER:

Shaping your future

SUSTAINABLE CUTTING SOLUTIONS

Next Level... ... The power to change everything.

MASTERLINE

TECHNOLOGY AND PRECISION MORE
ACCESSIBLE

Using all the technology Smart and MasterLINE combines quality,
performance and accuracy at a competitive price.

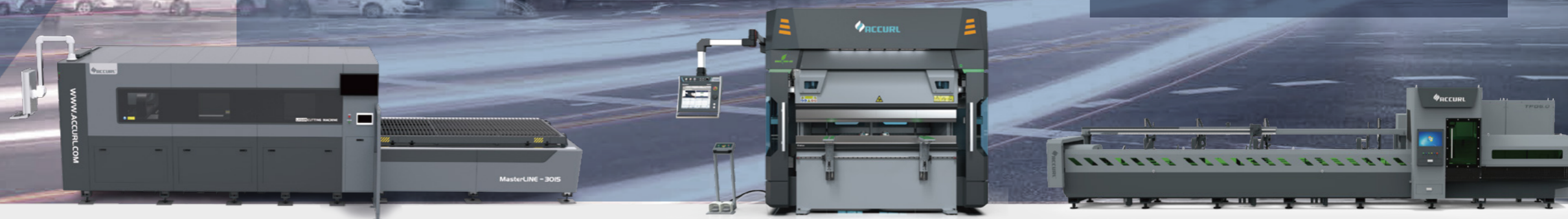

Laser cutting.

The most flexible tool ever



FLEXIBLE

Suitable for a wide range of materials, including highly-reflective metals and high thickness mild steel. Ready for round, square and rectangular tubes.



RELIABLE

Fully-tested and reliable thanks to the 11 years of experience with the MasterLINE platform.



PROFITABLE

Low operating costs thanks to energy efficiency and reduced maintenance.



USERFRIENDLY

Single focusing lens system with automatic nozzle changer. Easy to use programming software and Prima Power operator interface.

**DON'T SETTLE
FOR A STANDARD LASER CUTTING,
CHOOSE A SUPERCUSTOM!**

STANDARD

- > TWINGAT[®] S80 CNC Control System
- > ACCURL[®] BLT Cutting Head
- > REXROTH[®] Highly Dynamic Servo Drive
- > ALPHA[®] Precision Reducer & RACK System
- > 60 [KW] Max. Laser Power IPG/MAX
- > ACCURL[®] Dynamic System 4.0: 3[G] Acceleration
- > Max. Cutting Speed 180 [m/min]
- > Repeatability 0,03 [m/m]
- > ACCURL[®] Fast piercing 2.0: Ultrafast perforation
- > CAD/CAM Software Nesting. iCUT
- > Class IV safety system and CE marking
- > Automatic Nozzle Cleaning 2.0
- > Graphite Anti-burn Technology
- > Industry 4.0 for sheet metal working



AVAILABLE
FEATURES
AND OPTIONS



ELEVATE YOUR PERFORMANCE IN 2D LASER CUTTING

High axes speeds and acceleration paired with a rigid mechanical structure to achieve excellent cutting performance and accuracy.

**BEST
QUALITY
HIGH
ACCURACY**

CHOOSE THE SAFETY FOR YOUR JOB

Work safely and confidently: ACCURL laser is a CE marked Class 1 system and machines with maximum gain in speed, precision and efficiency.

4. 
INDUSTRY

THE COMPONENTS GUARANTEE PRECISION CUTTING:

Thanks to having the highest quality components such as: IPG laser/Max fiber source, Precitec/BLT cutting head or modern body ACCURL laser cutters can operate continuously 7 days a week, 365 days a year. The top performance of the machine and the low operating costs make the ACCURL laser the most frequently used system for demanding mass production.

MasterLINE
NEXT

- Low operating cost and energy consumption
- Globally recognized high performance components
- Precise cuts and high durability
- High profit margin

The MasterLINE series of laser cutting machines are characterized by high dynamics and top quality. They achieve a positioning speed of up to 180m/min and acceleration of 3G. Each laser cutter is available with a fiber laser source with power from 3kW to 60 kW.

STANDARD CUTTING PARAMETERS

Material (Cutting Capacity)	3 kW	4 kW	6 kW	10 kW	12 kW	15 kW	20 kW	30 kW	40 kW	60 kW
Mildsteel(s235jr)	16mm	20mm	22mm	25mm	30mm	35mm	50mm	60mm	70mm	100mm
Stainless Steel(1.4301)	8mm	10mm	16mm	25mm	25mm	30mm	40mm	50mm	70mm	90mm
Copper	4mm	5mm	6mm	8mm	8mm	10mm	12mm	12mm	16mm	30mm
Aluminum (AlMg3)	6mm	8mm	16mm	25mm	25mm	30mm	35mm	40mm	70mm	120mm
Brass	4mm	6mm	12mm	14mm	16mm	18mm	20mm	20mm	25mm	35mm

* Factors such as rust, shell formation, paint, label, pitch shifts on the surface, rolling defects, rusts on the surface of the material, affect the black sheet cutting negatively. The top and bottom surfaces of the material to be cut must be clean. The cutting quality and cutting speeds of sandblasted sheets vary.

LASER CUTTING CNC WTINCUT S80...

ACCURL TwinCut S80 is EtherCAT bus system designed for ultra high power fiber laser above 8KW, featured by out of box service, easy to install and adjust, full solution functions. It supports customization, automation and informatization solutions, is the leading edge EtherCAT laser cutting control system on the market.

TwinCut S80

The Laser Experience Make The Difference

The machine automation by TWINCUT S80 encompasses: drive technology, control systems, HMI, machine vision as well as seamless integration in TwinCAT Analytics based digital solutions for Industry 4.0

LASER CUTTING WTINCUT S80 CONTROLLER SYSTEM:

BECKHOFF TWINCUT S80

©Optional*

TWINCUT S80 EtherCAT CNC SYSTEM FEATURES

- High-speed EtherCAT communication.
- Highly dynamic servo drive technology.
- Integrated retention brake control.
- Automatic adaptation of parameters.
- Technology table for all relevant cutting parameters:
Speed: Maximum acceleration 5G, maximum single spindle speed 300m/min.
Accuracy: Theoretical path accuracy $\pm 0.005\text{mm}$, positioning accuracy 0.01mm.
- Provide access with laser cloud & MES to collect machine status data & inform maintenance to prolong machine usage.

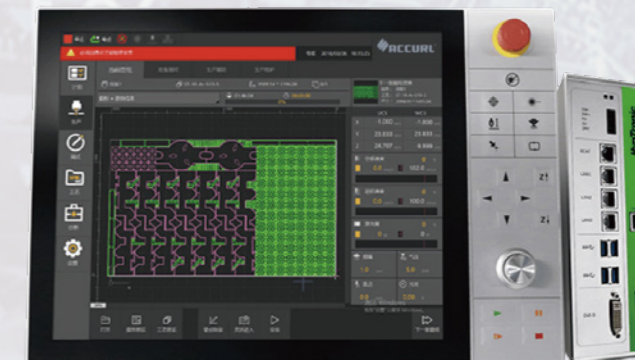

CONTROL PERFORMANCE

TwinCut S80 CNC controllers are used in laser cutting machine and the TwinCAT NC I/CNC automation software is ideally suited for application-specific functions including adaptive jet control, reverse travel or path resetting.

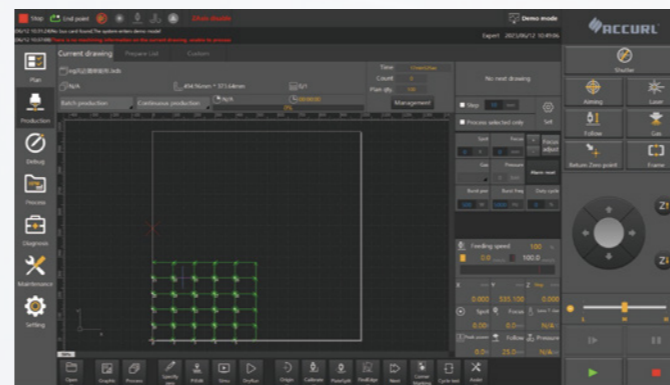

ADVANCED

- User friendly and touch optimized.
- Easy and efficient operation.
- Fly-cut option for significantly shorter cutting times.
- Nesting CAD/CAM software on board.
- Intuitive, step-by-step assistance for machine operators.
- Quick height adjustment for a very high and constant cutting quality.
- Integrated monitoring of peripheral units like laser sources and sensors.
- Support direct production of DXF & G code; support fast process of LXDS & NRP file generated by CypNest.

THE LASER EXPERIENCE MAKE THE DIFFERENCE:

The machine automation by Hypcut encompasses: drive technology, control systems, HMI, machine vision as well as seamless integration in TwinCAT Analytics based digital solutions for Industry 4.0.

ACCUPL BLT LASER CUTTING HEAD

The Smart Piercing and Auto Recut features, meeting the highly demanding standard of air as well as N2 high-power cutting considerably improve efficiency and yield

EFFICIENT AUTOMATED PERSISTENT

BEVEL HEAD ± 45 °

Bevel Head for vertical and bevel cuts from 0 ° to 45 °. Optimal results provided through the combination of 5 axis interpolation and software. Positive and negative bevel angles in one part.

©Optional*

STABLE AND FAST

ACCURL BLT Series smart cutters are especially developed for ultra-high power laser equipment (max of 40kw). Brand new beam path design and optimized optical lens bring you great performance with stable cutting, simple

VARIABLE BEAM ZOOM

The beam pattern can be switched at any time for different plates, advanced in cutting both thick and thin plates, doubling the efficiency.

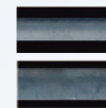

Homogeneous "Flat Top" distribution

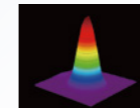
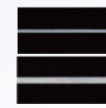

Gaussian distribution



BLT8X0H
(Zoom ≤20kW)



BLT6X2M
(12~40kW)



BLT6X2H
(12~60kW)



BLT4X1
(3~40kW)

PLANE CUTTING HEAD CATALOG

Function	Model	BLT4X1	BLT6X2H	BLT8X0H	BLT6X2M
		≤40KW	≤60KW	≤20KW	≤40KW
Protective Window Monitoring		✓	✓	✓	✓
Closed-Loop Monitoring		✓	✓	✓	✓
Nozzle Cooling		✓	✓	✓	✓
Cutting Gas Pressure Monitoring		✓	✓	✓	✓
Plane/Bevel Cutting		✓			
Smart Piercing			✓	✓	✓
O2/N2 Process Monitoring			✓	✓	✓
Variable Beam Shape				✓	
Cutting Path Monitoring					✓
Coaxial Monitoring					✓
Nozzle Quality Monitoring					✓
Nozzle Misalignment Monitoring					✓

Everything with one click in 3 steps. 100% automated

Optional item FABLE is an acronym of Fully Automated Cut & Bend BundLE and the operator has to set only the initial parameters: FABLE software and algorithms will handle the entire process in a fully automated way, including unfolding.

FULLY IN 3D, CUT BEND THE SHEET METAL

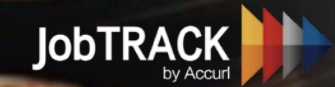

Job tracking add-on

Record and monitor the production/manufacturing process/flow
 Store all parts, tubes, daily jobs, SubNests.Sort and filter all the data, and search using complex search queries.
 Manage and monitor material consumption and usage efficiency

©Optional*

FABLE IN ACTION: 1,2 e 3. UNFOLDED,CUT AND BEND

ACCURL. Claim For 3D Unfolding

Consisting of a suite of outstanding applications,ACCURL.CLAIM allows you to fully control alle the phases of the creative process, converting ideas into technical drawings ready to be sent to the sheet metal working software.

ACCURL. iCut Nesting For Cutting

With ACCURLiCut software is designed to allow you to achieve the best cutting results, saving material, reducing time & making things easier for the operator, thanks to the high level of automation.

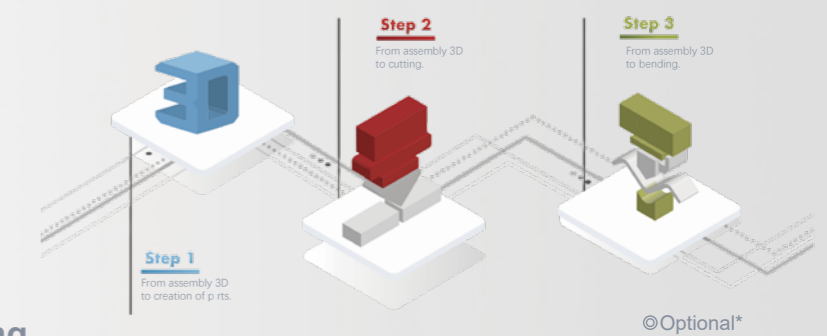

©Optional*

ACCURL. iBend Offline For Bending

Powerful and reliable, create or import geometric details in a moment from any other design platform, automatically optimizing their profiles and optimally preparing them for subsequent processing.

JopTRACK For Shop Management

For every 4 main phases of metal sheet cutting (quotation and order confirmation, order elaboration and warehouse checking for production) the JobTRACK system by ACCURL offers the more suitable software able to support at best the workforce in the relevant decisions and schedules.

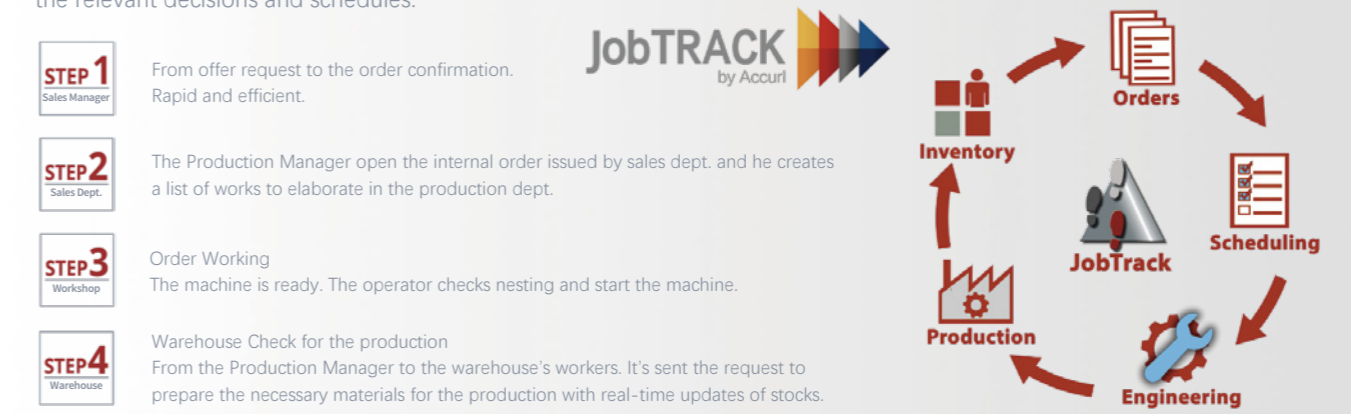

The Smart Piercing and Auto Recut features, meeting the highly demanding standard of air as well as N2 high-power cutting considerably improve efficiency and yield.

ACCURL.iCut 2D NESTING SOFTWARE*

iCut Software cutting creates programs for your cutting machine from CAD files and designs:
The ACCURL.iCUT CAM unique application for the programming of any type of cutting machines: laser, plasma, oxyfuel, waterjet.

ACCURL.iCut

The most efficient nesting of parts by Accurl



ACCURL.iCUT NESTING 2D PROGRAMMING SOFTWARE

ACCURL.iCut software is designed to allow you to achieve the best cutting results, saving material, reducing time & making things easier for the operator, thanks to the high level of automation.



A WINNING FORMULA

Automation + Integration + Efficiency + Productivity:

The best of the technological research of iCUT in a powerful and intelligent application, which reduces the processing time. In iCUT, the software engineers and analysts have concentrated the best Of ACCURL.iCUT technological know-how in theme of sheet cutting.

SETUP REPORTS

ACCURL iCut AutoNest is a recent addition to AutoNest. It includes an automatic nesting algorithm that dramatically improves both nesting quality and speed.

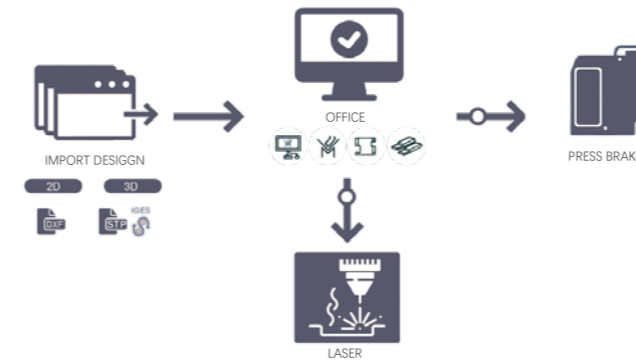

ADVANTAGE

- Full automation available in every step of the programming process
- Ability to manage all the cutting machines with the same system
- Optimization of nesting with the [ISA] system and less scrap
- Optimized generation of nesting on uneven scraps
- Reduction in the number of piercings and route optimization
- Optimal management of cutting conditions

DRAWING MODIFICATION AND IMPORT

- Intelligent parts recognition, drawing error identification & optimization.support file formats of DWG and DXF. Support batch create and import parts via Excel table.

ACCURL. iCUT IS AVAILABLE FOR

- **Management of FMS lines and / or of the manual operations**
 - Reduction of the cutting number of different nesting
 - Automatic Skeleton cutting
 - Systems management of loading / unloading and sorting systems

- **Nesting Strategy**

Powerful algorithm engine of high efficiency and production rate; no limit of sheet and parts quantity in nesting; support manual and automatic nesting; support free form sheet nesting.

- **Setup Reports**

Comprehensive iBend reports include all the information the operator needs to set up the tooling and bend the part.

- You can generate your report files in several formats: PDF, DOC, RTF, XLS\XLSX, XML, CSV, and RPT.

The iBend comes with real-time, automatic 3D simulation, presenting a realistic visualization of the bending process. and the simulation helps you to create an error-free process, producing NC code or a bending report

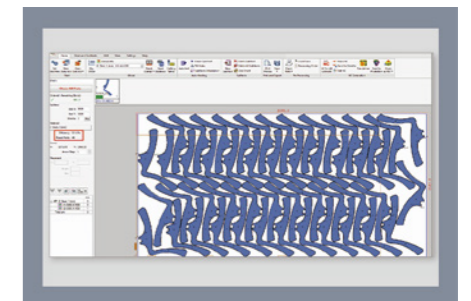
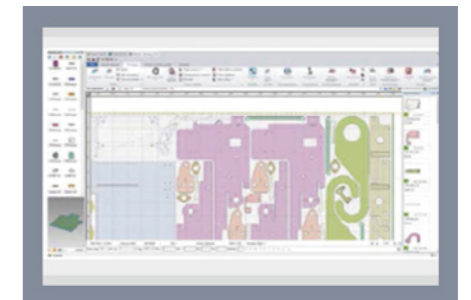

SMART CUBE

Experience precision and efficiency with the Cube Compact laser cutting machine an ideal solution for compact laser cutting. This innovative system seamlessly integrates precise 2D laser cutting into a sleek, space-saving design.

CONFIGURATION

- FSCUT 4000E TwinCAT Control System
- YASKAWA Highly dynamic Servo System
- ACCURL BLT Cutting head (Auto Focus)
- High-Pressure Valve N₂,O₂
- Graphite Anti-burn Technology

ACCELERATION

SIMULTANEOUS AXIS ACCELERATION > 1G

KEY FEATURES

Compact Design:
Minimization floor space without compromising cutting quality.

Range of Laser Sources:
Choose from 1 to 6 kW laser sources for versatility in production.

Manually Retractable Cutting Table:
Simplifies loading and unloading for increased efficiency.

High Precision:
Achieve highly precise cuts at high speeds, perfect for intricate parts production.



Performance	
Max. X Y speed	100 m/min
Maximum XY acceleration	60 m/s ²
Accuracy	±0.05 mm
Repeatability	±0.03 mm
Working capacity	
Processable metals	Mild steel, stainless steel, aluminum, copper, brass
Maximum sheet dimensions	1.050 mm x 2.035 mm [Cube-2010] 1.300 mm x 2.020 mm [Cube-2512] 1.530 mm x 3.050 mm [Cube-3015]

AVAILABLE MODELS

2000 x 1000 > 2500 x 1250 > 3000 x 1500

LASER POWER IPG/MAX PHOTONICS

1000 W > 6000 W

MASTERLINE

Enhance your productivity with cutting-edge 2G axis acceleration minimizing processing cycle times and eliminating delays. Fine-tune your laser system from 3Kw to 15Kw, leveraging Active Tools technologies for optimized metal cutting processes, ensuring industry-leading efficiency and innovation.

CONFIGURATION

- TwinCut S80 TwinCAT Control System
- Yaskawa Highly dynamic Servo System
- ACCURL BLT Cutting head (Auto Focus)
- High-Pressure Valve AIR,N2,O2
- Graphite Anti-burn Technology
- Class IV safety system and CE marking.

ACCELERATION

SIMULTANEOUS AXIS ACCELERATION > 2G

1

SEAMLESS AUTOMATION AND INTEGRATION

Ideal for unmanned operations, thanks to versatile sheet loading, unloading, and storage solutions. Seamlessly integrate with your company network for Industry 4.0 readiness, ensuring a future-proof manufacturing environment.

2

MAXIMIZE PRODUCTIVITY

Experience unparalleled production efficiency with swift pallet changes and a robust mechanical structure, ensuring undisputed speed and precision.

3

SEAMLESS USER EXPERIENCE

Utilize the integrated laser parameter database, covering various materials and thicknesses, enabling immediate production readiness for any task.

Performance	
Max. X Y speed	150 m/min
Maximum XY acceleration	20 m/s ²
Accuracy	±0,05 mm
Repeatability	±0,03 mm
Working capacity	
Processable metals	Mild steel, stainless steel, aluminum, copper, brass
Maximum sheet dimensions	3.050 mm x 1.535 mm [MasterLINE-3015] 4.080 mm x 2.020 mm [MasterLINE-4020] 6.130 mm x 2.550 mm [MasterLINE-6025]



AVAILABLE MODELS

3015 > 4020 > 6025

LASER POWER IPG/MAX PHOTONICS

3 kW > 15 kW

100 m/min
60 m/s²
±0,05 mm
±0,03 mm

MASTERLINE **PLUS**

The ML Series laser cutting machines exemplify technical excellence, precision dynamism and efficiency. Tailored for high-demand mass production tasks, they excel in cutting intricate components for electric motors and complex shapes with unparalleled precision and speed.

CONFIGURATION

- TwinCut S80 TwinCAT Control System
- REXROTH Highly dynamic Servo System
- ACCURL BLT Cutting head (Auto Focus)
- High-Pressure Valve AIR,N2,O2
- Graphite Anti-burn Technology
- Nozzle Misalignment Monitoring
- Class IV safety system and CE marking.

SIMULTANEOUS AXIS SPEED

SIMULTANEOUS AXIS ACCELERATION > 3G

FULL ELECTRIC PALLET CHANGER !

With the full electric pallet changer alone, you can increase productivity by up to 9% (with an average of 10 pallet changes per hour). It only takes a few seconds to extract the laser-cut parts and load the new sheet metal.

1

Wide chains

2

3 times faster than hydraulic lifting platforms

3

High positioning precision

4

Visible exchange process

Performance	
Max. X Y speed	180 m/min
Maximum XY acceleration	25 m/s ²
Accuracy	±0,05 mm
Repeatability	±0,03 mm
Working capacity	
Processable metals	Mild steel, stainless steel, aluminum, copper, brass
Maximum sheet dimensions	3.050 mm x 1.535 mm [MasterLINE-3015] 4.080 mm x 2.020 mm [MasterLINE-4020] 6.130 mm x 2.550 mm [MasterLINE-6025] 8.130 mm x 3.050 mm [MasterLINE-8030] 12.100 mm x 2.550 mm [MasterLINE-12025]



AVAILABLE MODELS

3015 > 4020 > 6025 > 8030 > 12025

LASER POWER IPG/MAX PHOTONICS

12 kW > 60 kW

SMART GIANT

SMART Giant is a high-capacity fiber laser system designed for large-format cutting applications with featuring a distinctive modular architecture, this machine offers a base bed length of 12 meter, expandable in 4 meter increments up to a maximum of 40 meter the SMART Giant model is capable of accommodating workpieces with widths of up to 3meter and thicknesses of up to 100mm.

CONFIGURATION

- TwinCut S80 TwinCAT Control System
- YASKAWA Highly dynamic Servo System
- ACCURL BLT Cutting head (Auto Focus)
- High-Pressure Valve AIR,N2,O2
- Graphite Anti-burn Technology
- Class IV safety system and CE marking

SIMULTANEOUS AXIS ACCELERATION > 2G

1 MODULAR DESIGN

Expandable from 10M to 40 meter for versatile applications

2 LARGE-FORMAT CUTTING

Process large parts continuously, minimizing repositioning

3 HIGH DYNAMICS

Ensures maximum precision and throughput in large-scale cutting

4 HIGH-TECH CUTTING HEAD

Designed for high power and 24/7operation for exceptional cutting performance

Performance	
Max. X Y speed	100 m/min
Maximum XY acceleration	60 m/s ²
Accuracy	±0,05 mm
Repeatability	±0,03 mm
Working capacity	
Processable metals	Mild steel, stainless steel, aluminum, copper, brass
Maximum sheet dimensions	12.250 mm x 3.100 mm [Smart Giant-12030] 16.250 mm x 3.100 mm [Smart Giant-16030] 20.500 mm x 3.100 mm [Smart Giant-20030] 24.500 mm x 3.600 mm [Smart Giant-24035]

AVAILABLE MODELS

12m x 3m > 16m x 3m > 25m x 4m

IPG/MAX PHOTONICS

LASER POWER

12kw / 15kw / 20kw / 30Kw / 40kw / 60kw

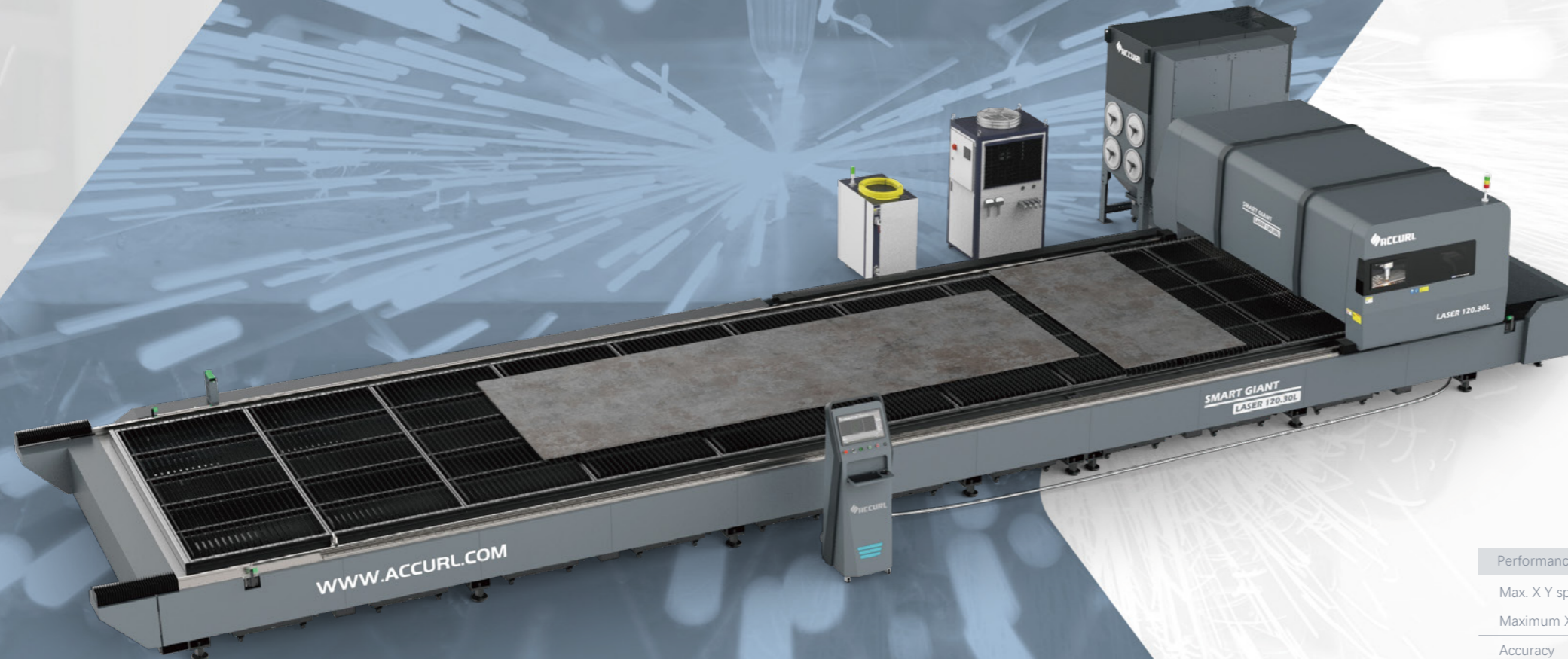

WWW.ACCURL.COM

HIGHPOWER CW FIBER LASER FOR METAL CUTTING

The IPG YLR & YLS series is the latest super-compact hermetic cabinet packaging of kW-class lasers in power 1-30 kW range incorporating all of the features and technology advancements of YLS-CUT series.

COST SAVINGS FROM OPTIMAL CUTTING QUALITY



YLS-SERIES ECO

Highest-Efficiency High-Power Fiber Laser

YLS-20000 & YLS-30000 ECO fiber lasers offer industry record energy efficiencies over 50% paired with unmatched reliability and long-term power stability.



FEATURES

- > 40 kW-60 kW Continuous Wave Laser Power
- > Low Operating Cost
- > Record Reliability & Stability
- > **50% Energy Efficient**
- > Maintenance-free Operation
- > Compact & Rugged Design



IPG ECO SERIES FIBER LASERS ARE UP TO **2X** MORE ENERGY EFFICIENT THAN OTHER FIBER LASERS



YLS-ECO high-power fiber lasers offer the highest energy efficiencies with unmatched reliability. Less input power required dramatically reduces energy costs without sacrificing output power.

	IPG	Other Fiber Laser
Power Consumption	40 kW	60 kW
Energy Efficiency	50%	33%
Cooling Capacity	20 kW	41 kW
Laser Energy Cost	22,560 USD	34,180 USD
Chiller Energy Cost	6,770 USD	13,740 USD
Total Energy Cost	29,330 USD	47,920 USD

IPG 30 kW ECO Energy Savings

*Annual Energy Savings
\$18,590

3 Year Energy Savings
\$37,180

5 year Energy Savings
\$55,770

*Savings example based on energy cost \$0.16/kWh, 75% duty cycle and 16 hour/day operation. Customer savings varies by actual energy cost, duty cycle and hours of operation. Other fibers lasers are typically 25 - 35% energy efficient.

TECHNOLOGIES FOR LASER MACHINES

The ACCURL Loader & unloader BRG System 2.0 is the automated solution that best optimizes the flow of material, which improves both the safety at work and the safety of the process. The solutions included range from simple operation to fully automated operation.



LIGHTS-OUT PRODUCTION

Combo Tower Laser also provides an optimal solution for lights-out production as capacity of available raw materials and unloading positions for skeletons can meet production requirements. Combo Tower Laser can be equipped with Night Train FMS® connection

THE WORLD OF SHEET PROCESSING

The Combo Tower Laser is a flexible storage system with integrated loading and unloading features for 2D lasers. It makes different materials available whenever needed automatically and without delays; it can also serve as intermediate storage for ready cut components along with skeleton.

SMART-LIFTER

- Loading/unloading device for handling blanks and processed sheets.
- Two storage units (one for the blanks and one for the processed sheets).
- Single sheet separating and control systems and sheet reference.

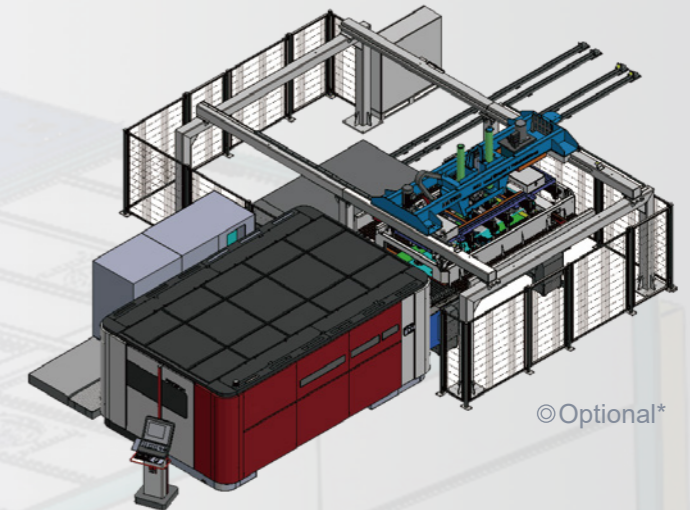

©Optional*

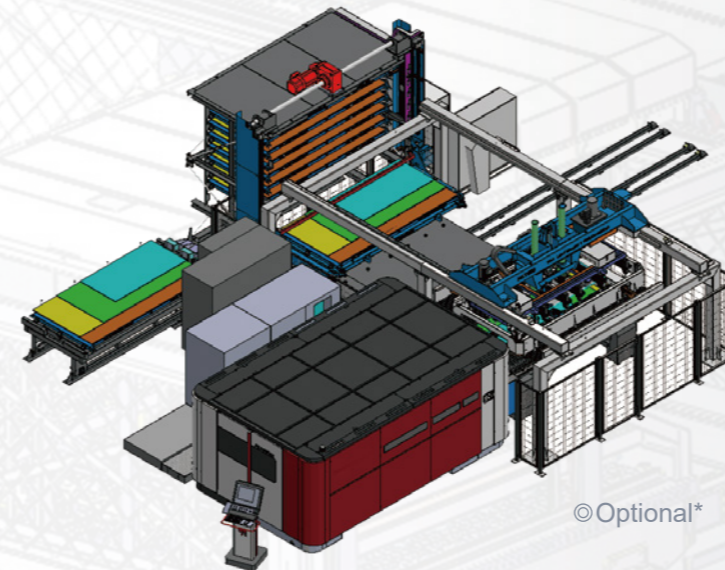

©Optional*

SMART-TOWER

- Loading/unloading devices for handling blanks and processed sheets.
- Storage tower with 10 or 15 pallets.
- Single sheet separating and control Systems and sheet reference.
- Very limited footprint.