

ACCURL PRODUCT RANGE:

EUROMASTER
Medium sizes

EB ULTRA
Small sizes



ES NT-30T



MASTERLINE
All sizes



TUBELINE
All sizes

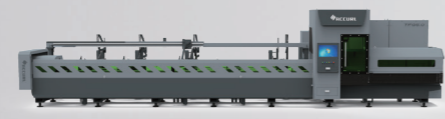

SMART BEC
Medium sizes

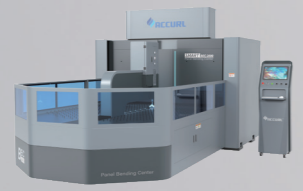

TUBELINE
NEXT



Shaping your future

ACCURL MACHINE TOOLS
ANHUI | CHINA

Industrial Park in Bowang Special
Economic Zone Maanshan
Anhui | China

T | +86 0555 2780563
M | +86-188 5555 1088
E | info@accurl.com

ACCURL.com

LOCAL DEALER

SUSTAINABLE CUTTING SOLUTIONS

Next Level... ... The power to change everything.

TUBELINE SERIES TUBE LASER CUTTING MACHINE

ACCURL makes tube manufacturing more efficient and cost-effective with laser cutting technology. Using a single, flexible tool, a variety of tube shapes can be processed – with high cut quality and accuracy that simplifies or eliminates secondary processes.



MASTERLINE
All sizes

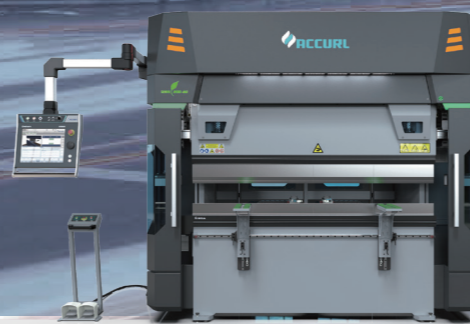

TUBELINE
All sizes



TUBELINE
All sizes

Laser cutting.

The most flexible tool ever



FLEXIBLE

Suitable for a wide range of materials, including highly-reflective metals and high thickness mild steel. Ready for round, square and rectangular tubes.



RELIABLE

The tube lasers have opened up new design possibilities so more and more designers are taking advantage of the benefits of laser-cut tubes and profiles thereby considerably increasing demand.



PROFITABLE

The machine completes many tasks itself - this saves you money and prevents errors.



USERFRIENDLY

Operation made easy: the machine is easily accessible with minimum set up

STANDARD

- > Machine Model: TubeLINE-SERIES
- > Laser Cutting Head: ACCURL BLT Series (Auto Focus)
- > Laser Sources: IPG & MAX Photonics
- > Material Size Range: Round tube 15-500mm
- > For LoadMaster Tube: 6M / 7m / 9m / 12m
- > Maximum Tube Length & Weight: 12000mm, 1200kg
- > Motion System: Yaskawa Servos & Drivers - X,Y,Z Axis
- > X.Y.Z axis position accuracy: $\pm 0.02\text{mm}$
- > User Interface (HMI): ACCURL 21.5" Touch Screen with Camera Display
- > Fume Extraction: With Optional Dust Collector
- > Class IV safety system and CE marking



AVAILABLE
FEATURES
AND OPTIONS

**DON'T SETTLE
FOR A STANDARD LASER CUTTING,
CHOOSE A SUPERCUSTOM!**

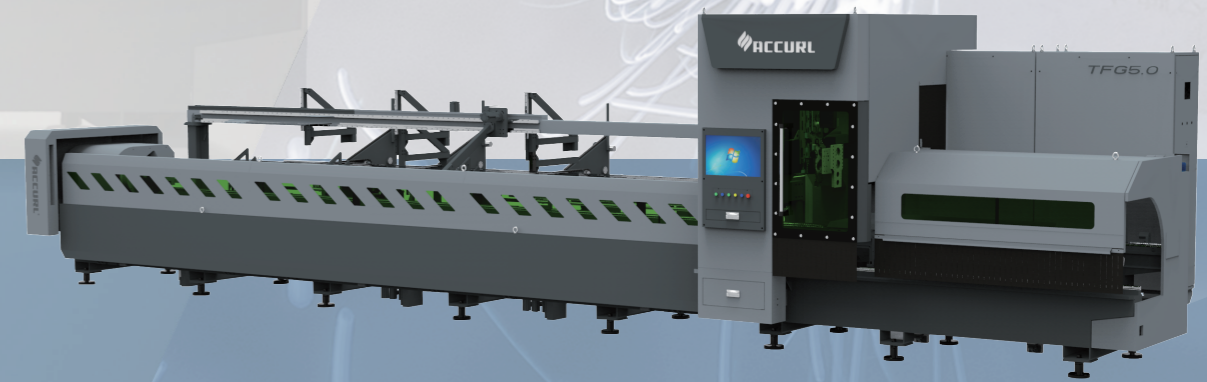

TOP QUALITY AND EXCELLENT OPERABILITY

The TubeLine fiber is the ideal machine for getting started in laser tube processing and as a supplementary machine.

COMPACT AND EFFICIENT TUBE CUTTING



APPLICATION SOLUTIONS

EASIER POSITIONING, CONNECTING AND ASSEMBLING :

Clever designs with laser tube cutting simplify your processes: prepare your parts perfectly for subsequent work steps.

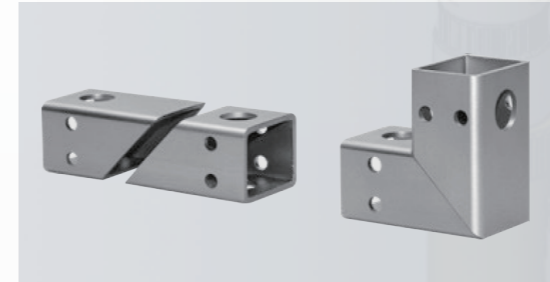

Thanks to bevel cuts of up to 45°, you can further process corner connections more quickly – with optimal material utilization.



Use tube-blank connections for simple fixing, optionally with lugs or coding function.

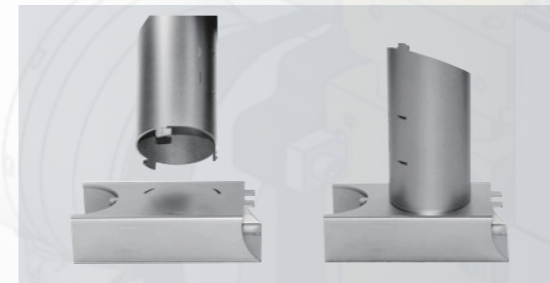

Replace time-consuming welding fixtures with plug, dovetail and bayonet connections.

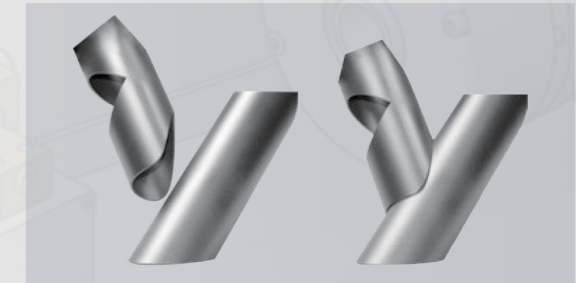

Connect tubes together easily using attachments – the perfect option for load-carrying tube designs.

THE BEST CHOICES SHOW THEIR VALUE OVER TIME

ADVANTAGE:

- Reduce piercing times with Pierce 2.0, depending on the material type and thickness, by 10 – 60% compared to preset values.
- One cutting head for all wall thicknesses is all you need thanks to the single cutting head strategy of ACCURL.
- Protect the cutting head and avoid collisions using the Controlline function – the distance between the cutting nozzle and the surface remains constant, even with uneven tube surfaces.
- Adapt the focus position to the material type and thickness using the automatic Focus function.



Efficient production of bend connections and positioning aids with a laser.

ELEVATE YOUR PERFORMANCE IN 2D LASER CUTTING

High axes speeds and acceleration paired with a rigid mechanical structure to achieve excellent cutting performance and accuracy.

BEST QUALITY HIGH ACCURACY

CHOOSE THE SAFETY FOR YOUR JOB

Work safely and confidently: TubeLINE is a CE marked Class IV system, and machines with maximum gain in speed, precision and efficiency.



TUBE LASER CUTTING MACHINE SERIES

Intelligent operation system, with tubes graphs warehouse and integrated splicing process of multiple tubes. Professional control system, to realize intelligent cooperation of machine tools. Butler-type machine tool debugging and maintenance plan, safe and reliable. Tube cutting graphics flattening and other rich cutting auxiliary functions, convenient and intuitive.



TUBELINE NEXT

- Particularly cost-effective
- High-quality bevel cuts
- Cutting and clamping with precision
- Reliable functions and robust design

Fully automatic system, high-efficiency and fast loading, realizing the hoisted loading of the whole bundle of tubes. Tube materials are divided intelligently by the system, automatically loaded and measured, to save labor costs of manual loading and improve work efficiency.

STANDARD CUTTING PARAMETERS

Model	TubeLINE A Series	TubeLINE BK Series	TubeLINE D Series
Power	1500W~6000W		3000W~12000W
Processing range	φ 200 φ 280 φ 360	φ 200 φ 280 φ 360	φ 280 φ 360 φ 500
For LoadMaster Tube	6000mm / 7000mm	6000mm / 7000mm / 9000mm	9000mm / 12000mm
Max no-load running speed	100m/min	100m/min	101m/min
Max idle speed	100r/min	100r/min	85r/min
Max mass of single pipe	250kg	350kg	1200kg
For unloading	≤3000mm	≤3000mm / 6000mm	≤6000mm / 10000mm / 12000mm

To cut Conventional Tubes Profiles and Special-shaped Tubes

The Independent research and development of the chuck with good sealing and motion characteristics, can hold square tube, round tube, elliptical tube, flat tube, triangle tube, I-beam and other materials.

EXCELLENT PROCESS RELIABILITY

WHY ACCURL TubeLINE ?

- The right tube laser
 - Innovative features such as bevel cutting
 - Comprehensive technology and cutting data
 - Ergonomic machine concepts
- Our functional features and expertise support tubes and profiles through every stage of the machine. Each component is optimized for maximum results, delivering real benefits at every step.

©Optional*

CHUCKS AND CLAWS

Two high quality rotate chuck move with synchronous rotation, which ensure tube holding more steady . It reduce tube vibration to minimum, with solid guarantee for high accuracy in complicate tube figure.Suitable for cutting tube with diameter range from Ø20mm to Ø520mm.

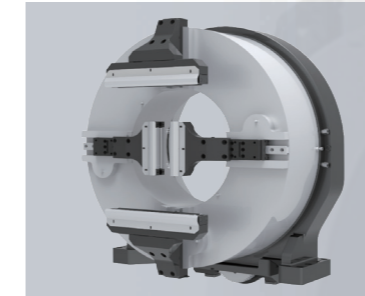
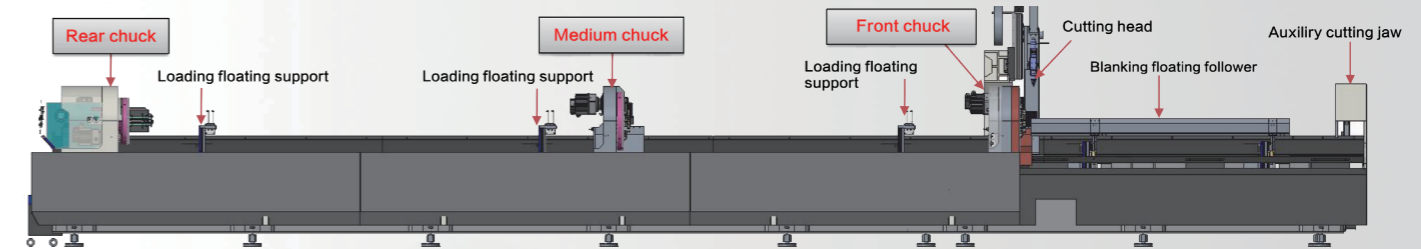

PNEUMATIC REAR CHUCKS:

- The chucks are outfitted with pressure feedback system to adjust cutting pressure based on tube size and thickness. They are also featured by auto recognition of different tubes and real-time warning with no or less manual intervention.
- Cutting range:φ10 - 219mm & □10*10 - 150*150mm.
- Load-bearing :170Kg.

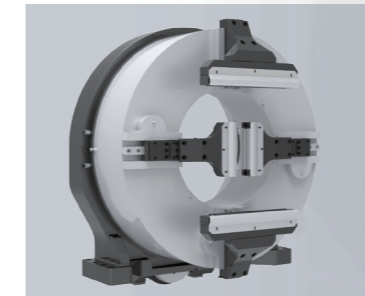

PNEUMATIC MEDIUM CHUCKS:

- The three chuck real-time to maintain the pipe before and after three-point clamping positioning, cutting space-time running speed can achieve max stable cutting, relative cutting efficiency to be high.

PNEUMATIC FRONT CHUCKS:

- The cutting machine clamping becomes convenient, easy and fast, with 3 seconds at the soonest to clamp and high repeat precision.

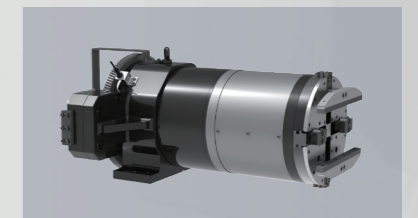

TubeLINE A Series

The simplest way to enter the tube laser cutting world

From a front-end material loader, to servo-controlled and synchronized tube supports, this semi-automated tube and profile laser is ready for your one-off parts or production demand. A linear front chuck allows for minimal tailing with optimal finished part support, and can be coupled with an optional synchronized out-feed to support finished parts.

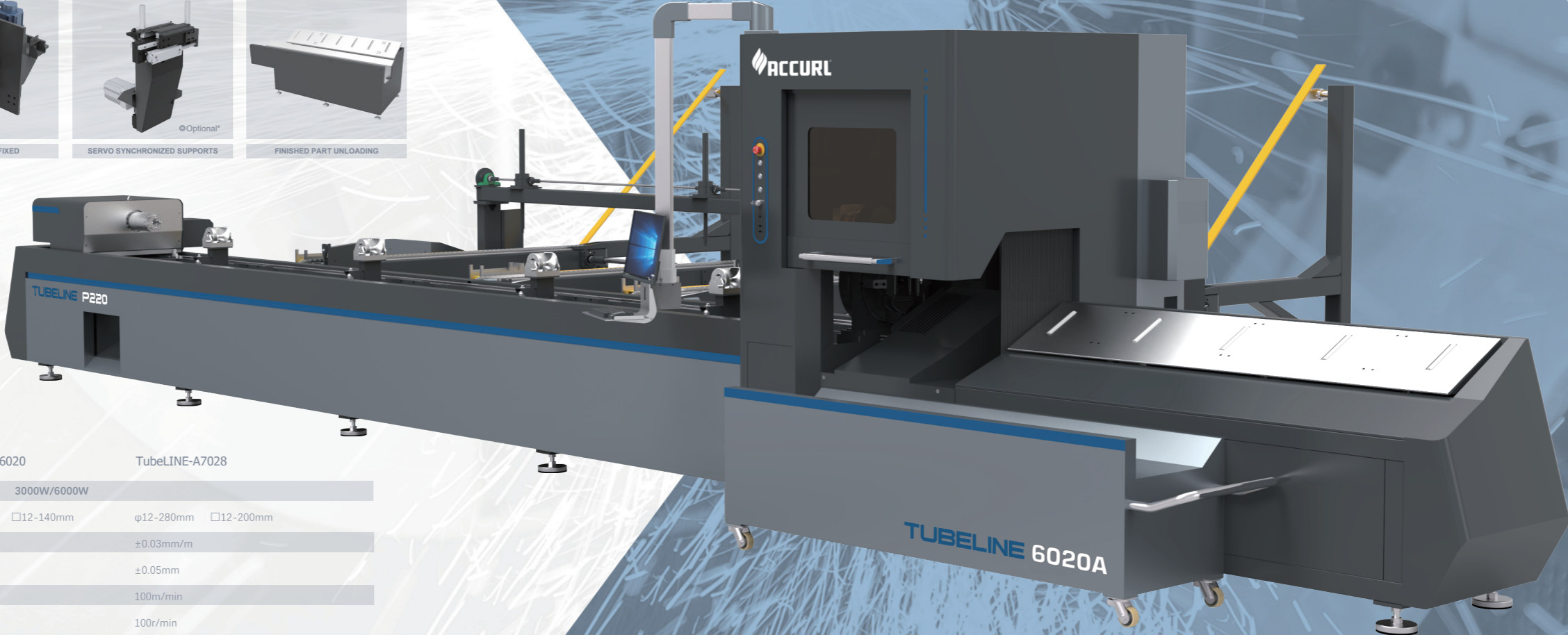
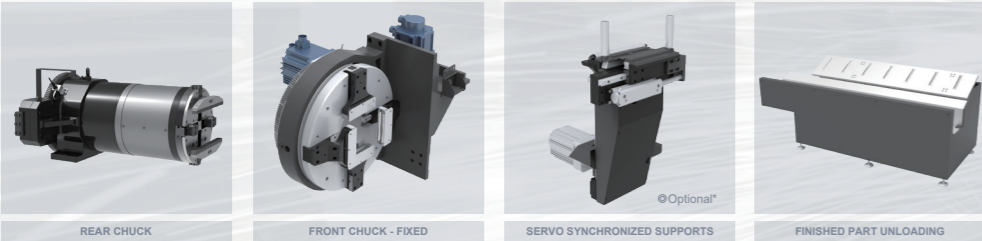

Model	TubeLINE-A6020	TubeLINE-A7028
Power	3000W/6000W	
Processing range	φ12-200mm □12-140mm	φ12-280mm □12-200mm
Positioning Accuracy	±0.03mm/m	
Repositioning Accuracy	±0.05mm	
Max no-load running speed	100m/min	
Max idle speed	100r/min	
Max mass of single pipe	250kg	
Feeding dimensions	≤3000mm	

TubeLINE BK Series

The fully-automatic solution that guarantees maximum productivity

ACCURL TubeLINE BK Series is a compact and efficient tube cutting solution with advanced technical features for optimal performance. It offers versatility, ease of use, & best-in-class engineering for processing various tube shapes. Ideal for frequent production changeovers and adapting to different materials. Invest in TubeLINE for a profitable cutting solution

FOLLOW UP SUPPORT SERVO DEVICE

The equipment integrates tube support and a righting mechanism. The flat support combats tube sagging, while the follow-up support minimizes rotational friction. The concave righting device safeguards tubes from deflection and loading-related collisions.



FOLLOW UP SUPPORT SERVO DEVICE

THREE FLEXIBLE SUPPORTING DEVICE

The pneumatic support system can be adjusted for various materials, ensuring easy alignment with the chuck to prevent swaying. An optional servo auxiliary support system with a follow-along bracket offers higher cutting precision than the reducer wheel for pipe cutting.



SERVO SYNCHRONIZED SUPPORTS



Model	TubeLINE-BK6020	TubeLINE-BK7028
Power	3000W/6000W	
Processing range	φ12-200mm □12-140mm	φ12-280mm □12-200mm
Positioning Accuracy	±0.03mm/m	
Repositioning Accuracy	±0.05mm	
Max no-load running speed	100m/min	
Max idle speed	100r/min	
Max mass of single pipe	250kg	
Feeding dimensions	≤3000mm	

TubeLINE D Series

The fiber solution for large diameter tubes and profiles

From front-end material loader and unloader, to servo-controlled and synchronized material supports, this semi-automated tube and profile laser is ready for your one-off structural parts or production demand. The TubeLINE D series Machine's 3 chuck design allows for ZERO tailing with optimal finished part support, and long finished part handling. With a 3D Cutting Head, this machine-tool comes ready for a wide range of structural tube and profile laser cutting applications both on square, round, channel, beam and other profiles.

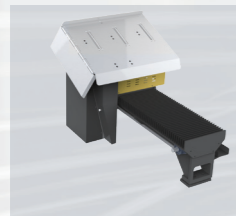

SMALL PART UNLOADING



MATERIAL LOADING

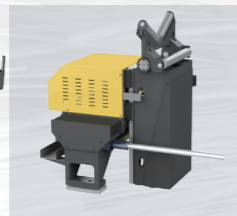

SERVO SYNCHRONIZED TUBE SUPPORTS



MATERIAL UNLOADING

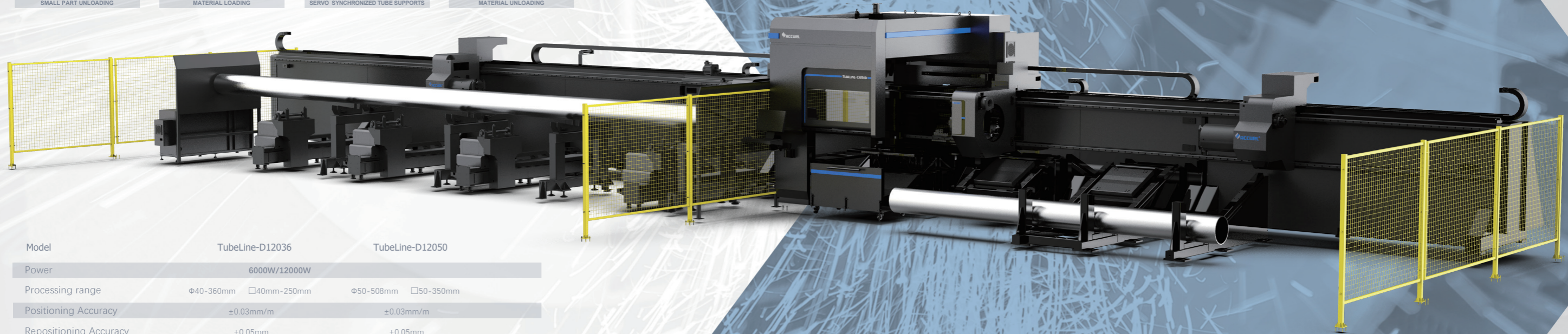

Model	TubeLine-D12036	TubeLine-D12050
Power	6000W/12000W	
Processing range	Φ40-360mm □40mm-250mm	Φ50-508mm □50-350mm
Positioning Accuracy	±0.03mm/m	±0.03mm/m
Repositioning Accuracy	±0.05mm	±0.05mm
Max no-load running speed	60m/min	40m/min
Chuck speed	80r/min	50r/min
Max mass of single pipe	1200kg	2000kg
Feeding dimensions	≤12000mm	≤6000mm

PRECITEC LASER CUTTING HEAD

The Precitec offers high-quality tailor-made solutions for all requirements and machine concepts in 2D laser cutting and has gained world wide recognition as the market leader in cutting optics, distance sensor technology, and process monitoring..

EFFICIENT AUTOMATED PERSISTENT

BEVEL HEAD $\pm 45^\circ$

Bevel Head for vertical and bevel cuts from 0° to 45° . Optimal results provided through the combination of 5 axis interpolation and software. Positive and negative bevel angles in one part.

©Optional*

BOCI BLT 3D BEVEL CUTTING LASER HEAD

Optional with a 3D Cutting Head, this machine-tool comes ready for a wide range of structural tube and profile laser cutting applications both on square, round, channel, beam and other profiles.

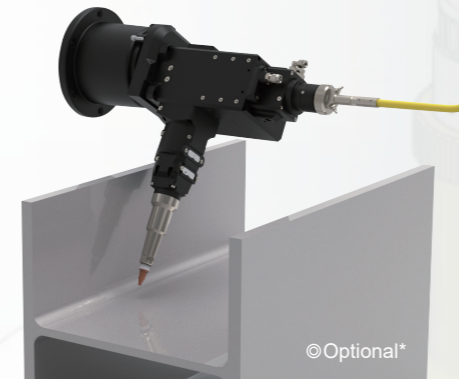

HIGH-POWER SMART CUTTER BLT 5 SERIES

ADVANTAGE

- -45° to $+45^\circ$
- Auto focus control
- Magnetic Anti-collision protection
- Swing direct-drive design
- Upper & Lower Protective window for protection of the collimation lens
- Drawer type Lower Protective window holder to facilitate quick daily inspection
- Well supported by ACCURL Parts & Service
- Cutting distance of at lowest 0.1mm
- High-speed capacitive sensing

HIGH-POWER SMART CUTTER BLT 4 SERIES

BLT 4 series, cost-effective smart cutter that focuses on 3D and bevel cutting machine delivers a great performance with stable cutting, simple installation and setup available for power levels below 30KW.

ADVANTAGE

- Excellent cut quality
- Low process time
- Easy to maintain
- Smooth cutting edges with minimal burrs
- LED operating status display
- Short process times
- Process-stable machining of thick materials

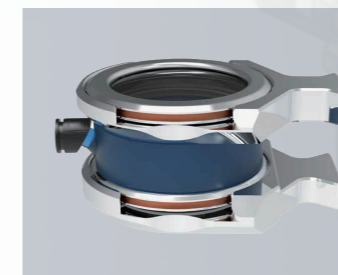

PAN-SEAL FAILURE DETECTION

High-Power Smart Cutter BLT 4 Series
Real-time monitoring of the sealing of the lower protection zone, effectively Extend the service life of the protective lens and ensure stable production.



EASY TO MAINTAIN LOW COST TO REPAIR

High-Power Smart Cutter BLT 4 Series
Ready-to-use optics drawer, lens changed in 5mins.



ANIT-COLLISION PROTECTION

High-Power Smart Cutter BLT 4 Series
Cutting head anti-collision design, effectively reduce the return factory, no need for after-sale visit, customer can replace by themselves, lower maintenance cost.

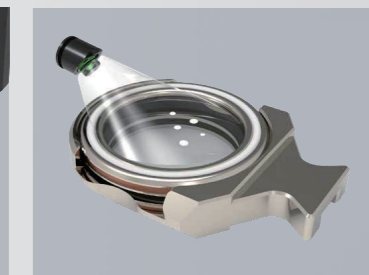

PROTECTIVE LENS TEMPERATURE MONITORING

High-Power Smart Cutter BLT 4 Series
The system monitors protective lens temperature in real-time. Upon reaching the preset maximum temperature, processing halts, triggering an alarm.

LASER CUTTING FSCUT 5000 SYSTEM

FSCUT5000 series is EtherCAT bus system specially designed for fiber laser tube cutting machine. FSCUT5000A applied to 3-chuck delivering structure, FSCUT5000B applied to 2-chuck structure, work with TubesT 3D nesting software, it will achieve most efficiency and minimum waste.



The Laser Experience Make The Difference

The machine automation by FSCUT5000 encompasses: drive technology, control systems, HMI, machine vision as well as seamless integration in TwinCAT Analytics based digital solutions for Industry 4.0.

FSCUT5000 EtherCAT CNC SYSTEM FEATURES



- High-speed EtherCAT communication
- Highly dynamic servo drive technology
- Integrated retention brake control
- Automatic adaptation of parameters
- Technology table for all relevant cutting parameters:
 - Speed: Maximum acceleration 5G, maximum single spindle speed 300m/min.
 - Accuracy: Theoretical path accuracy $\pm 0.005\text{mm}$, positioning accuracy 0.01mm.
- Provide access with laser cloud & MES to collect machine status data & inform maintenance to prolong machine usage.

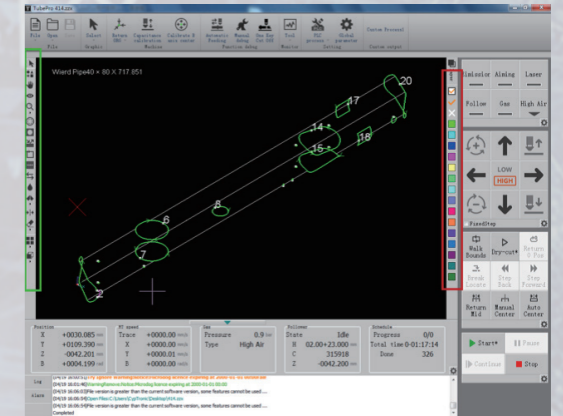

TUBEPRO SHEET NESTING SOFTWARE

TubePro designed for professional tube cutting, supports production of tube and profile of various shape. It works with TubesT nesting software seamlessly to realize technique setting, advanced toolpath generation and nesting for standard and special production need.

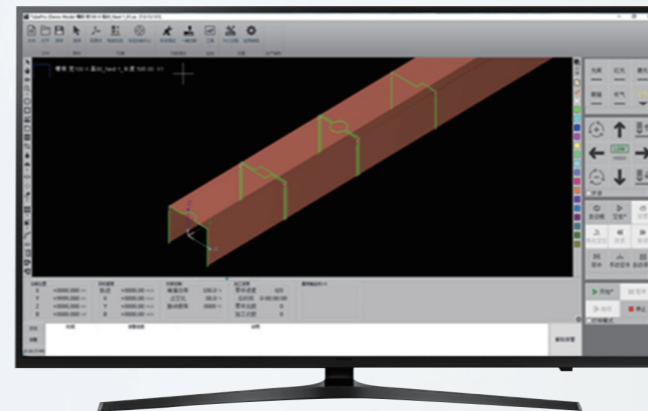

ADVANCED

- User friendly and touch optimized
- Easy and efficient operation
- Fly-cut option for significantly shorter cutting times
- Nesting CAD/CAM software on board
- Intuitive, step-by-step assistance for machine operators
- Quick height adjustment for a very high and constant cutting quality
- Integrated monitoring of peripheral units like laser sources and sensors
- Support direct production of DXF & G code; support fast process of LXDS & NRP file generated by TubePro

MORE OPPORTUNITIES TO BE EXPLORED

ATL Loading System is automatic and no manual adjustments are needed to change the section. For small run, for instance, the loading chains can be opened and the bars can be loaded in sequence.



QUALITY AND ACCURACY

FULLY-AUTOMATIC LOADING SYSTEM

Users can load standard-sized tube and enjoy batch production with little manual intervention. For round, square, rectangular tube, as well as angle, channel and H-shaped steel are loaded easily. and the tube to be cut is conveyed to check-waiting area for length measuring and cut sequencing.

ADVANTAGE:

- Easy tube loading for batch production.
- Max. linear weight 23Kg/m
- All Automatic Settings
- Bundle and single bar loading
- Three unloading positions
- Loading size range: p16-150mm, square pipe 16-150mm.
- Quick loading times: <60s first load, <20s subsequent.

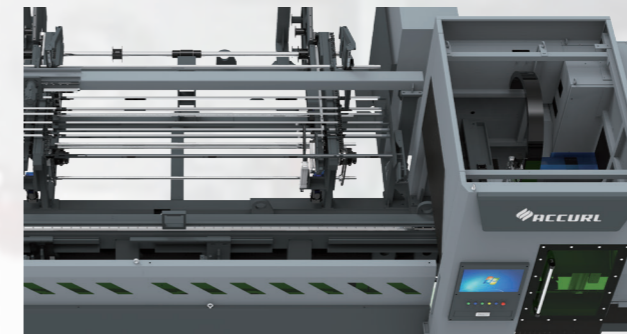
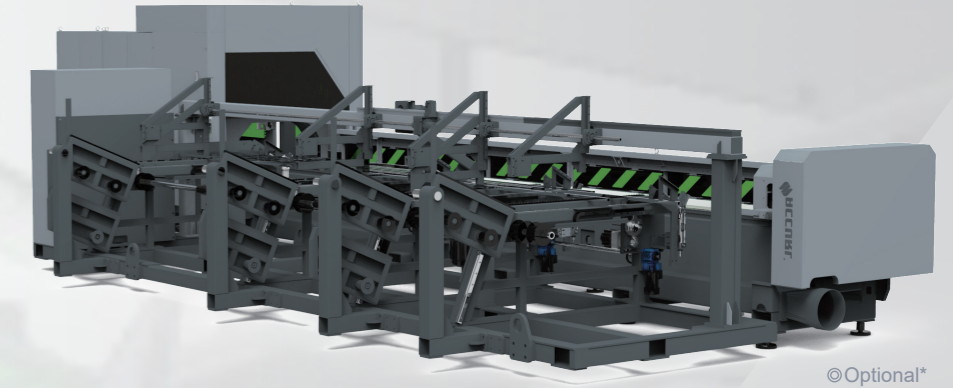

EXTREME FLEXIBILITY WITH POSSIBILITY

The rear loader allows quick extraction of loading chains, facilitating seamless integration with external robotic loading systems and automated storage solutions.

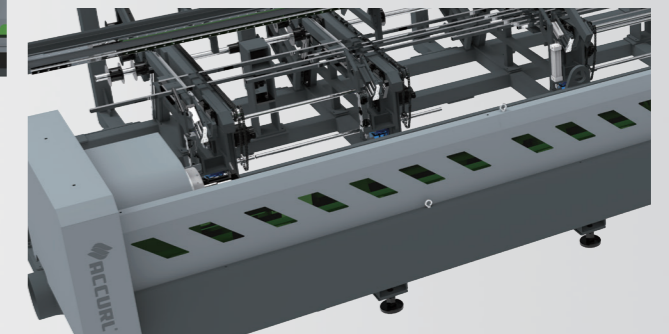

QUICK CHANGES OF PRODUCTION

Post-batch completion, the machine seamlessly readies itself for the subsequent task: automatic adaptation of loader, rear spindle, front steady rest, and intermediate supports to accommodate diverse sections - be it round, square, special, or open profiles.